

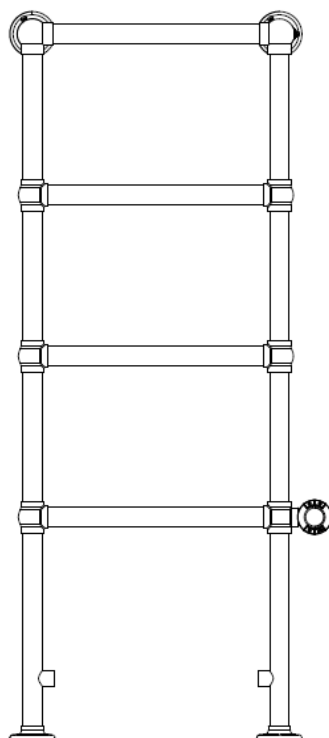

Thank you for choosing Better Bathrooms.
Please read this manual before installing your product
and keep for future reference.

better 
bathrooms

REGENT 1200mm TOWEL WARMER



REGBBE1200 (Brushed Brass)

REGMBE1200 (Matt Black)

- WIFI CONTROL
- IPX4 INGRESS PROTECTION

CONTENTS

SAFETY INFORMATION	3
INSTALLING IN A BATHROOM	5
PARTS LIST	6
INSTALLATION	6
OPERATION	7
SETTING UP THE APP	10
USING THE APP	14
CLEANING AND MAINTENANCE	18
TROUBLESHOOTING	18
TECHNICAL SPECIFICATIONS	18
SUPPORT	19
PSTI AND DECLARATION OF CONFORMITY	20

SAFETY INSTRUCTIONS

IMPORTANT: Carefully read the instructions before operating the unit. Retain for future reference and pass along with the appliance to any third party.

- This appliance is for indoor use only.
- This warmer has been tested and is safe to use. However, as with any electrical appliance - use it with care.
- The appliance must be installed by a competent person in line with all local and applicable regulations and standards.
- The means for an all-pole disconnection must be incorporated in the fixed wiring in accordance with wiring regulations.
- If the supply cord is damaged it must be replaced by the manufacturer, its service agent or similarly qualified persons in order to avoid a hazard.
- Always ensure the drilling and mounting area is free of pipes and wires and can bear the appliance's weight.
- Disconnect the power from the unit before dismantling, assembling, or cleaning.
- This appliance is not intended for use by persons (including children) with reduced physical, sensory or mental capabilities or lack of experience and knowledge unless they have been given supervision or instruction concerning the use of the appliance by a person responsible for their safety.
- Children should be supervised to ensure that they do not play with the appliance.
- When the appliance is on, please supervise children and pets to avoid injury.
- Some parts of this product can become very hot and cause burns. Particular attention has to be given where children and vulnerable people are present.
- Do not clean the unit by spraying it or immersing it in water.
- Never operate this appliance if the unit or cord is damaged. Ensure the power cord is not stretched, exposed to sharp objects/edges, or routed under the unit.
- Any service other than regular cleaning should be performed by an authorised service representative. Failure to comply could result in a voided warranty.
- Do not use an external timer.
- The warmer must not be located immediately below a socket outlet.
- Always ensure the unit is secure before operation. It must be securely attached to a suitable wall.
- Avoid keeping the unit in direct sunlight for long periods of time.
- The warmer is designed to be used at temperatures above 0°C. If it is exposed to temperatures below this, it must be allowed to warm above this level before operation.
- Do not attempt to repair, disassemble, or modify the appliance. This unit contains no user-serviceable parts.
- Always disconnect the appliance from the mains power supply when not in use or when moving or cleaning it. Do not pull the cord to unplug the warmer.
- Do not use the appliance for anything other than its intended use. It is designed for domestic indoor use only.
- There may be a trace of odour during the first few minutes of initial use or after a period of storage. This is normal and will quickly disappear.
- This appliance has hot and arcing or sparking parts inside. Do not use it in areas where gasoline, paint, or any flammable liquids are used or stored.
- Ensure the electrical connection and means for disconnection are not within reach of the bath or shower.
- Never locate this appliance where it may fall into a bathtub or otherwise become exposed to water.
- This appliance is IPX4 rated and so can be used or installed within a bathroom as long as the

appliance and its cables are not within Zones 0-2.

- If used within a bathroom, the circuit must be protected by a suitable RCD to prevent electric shock.
- Do not allow the appliance to be submerged or sprayed with water.
- **WARNING:** To reduce the risk of the towel warmer or electrical shock, DO NOT use this appliance with any solid-state speed control device or any variable speed controllers.
- Installation must be in accordance with all relevant local regulations applicable at the time of installation.
- If electrical work is carried out within the bathroom, which involves the addition or alteration of existing circuits, it may be notifiable to your local building control department (Part P). If unsure, professional advice should be sought.
- Ensure that your warmer is filled with glycol. If filling up your warmer with Glycol, ensure to leave room inside the unit for expansion. It is recommended to leave 10 per cent of the unit empty to allow for expansion of the liquid during operation. Your warmer comes prefilled.
- **IMPORTANT:** In case of skin exposure to chemicals, please rinse the skin thoroughly with soapy water and seek medical attention if the skin becomes inflamed or develops a rash.
- **IMPORTANT:** In case of eye exposure to chemicals, immediately flush eyelids with water for at least 15 minutes and seek medical attention.
- **IMPORTANT:** In case of ingested chemicals, drink plenty of water to dilute and seek medical attention as soon as possible.

Illustrations in this manual may differ from the final product, this is due to constant product development and improvement. There may also be slight variations between the different models covered in this manual.

INSTALLING WITHIN A BATHROOM

If the appliance is to be fitted within a bathroom, a good understanding of the zoning within bathrooms is required to ensure the unit is mounted in a safe position. The appliance is rated as IPX4 and should be installed outside of Zones 0 -2. We would advise when the unit is fitted within a bathroom, the plug is removed from the unit, and a suitable fused spur is installed in accordance with BS 7671. In addition, when used in a bathroom, it must be protected by a suitable RCD to prevent the risk of electric shock and must not be immersed in water when cleaning.

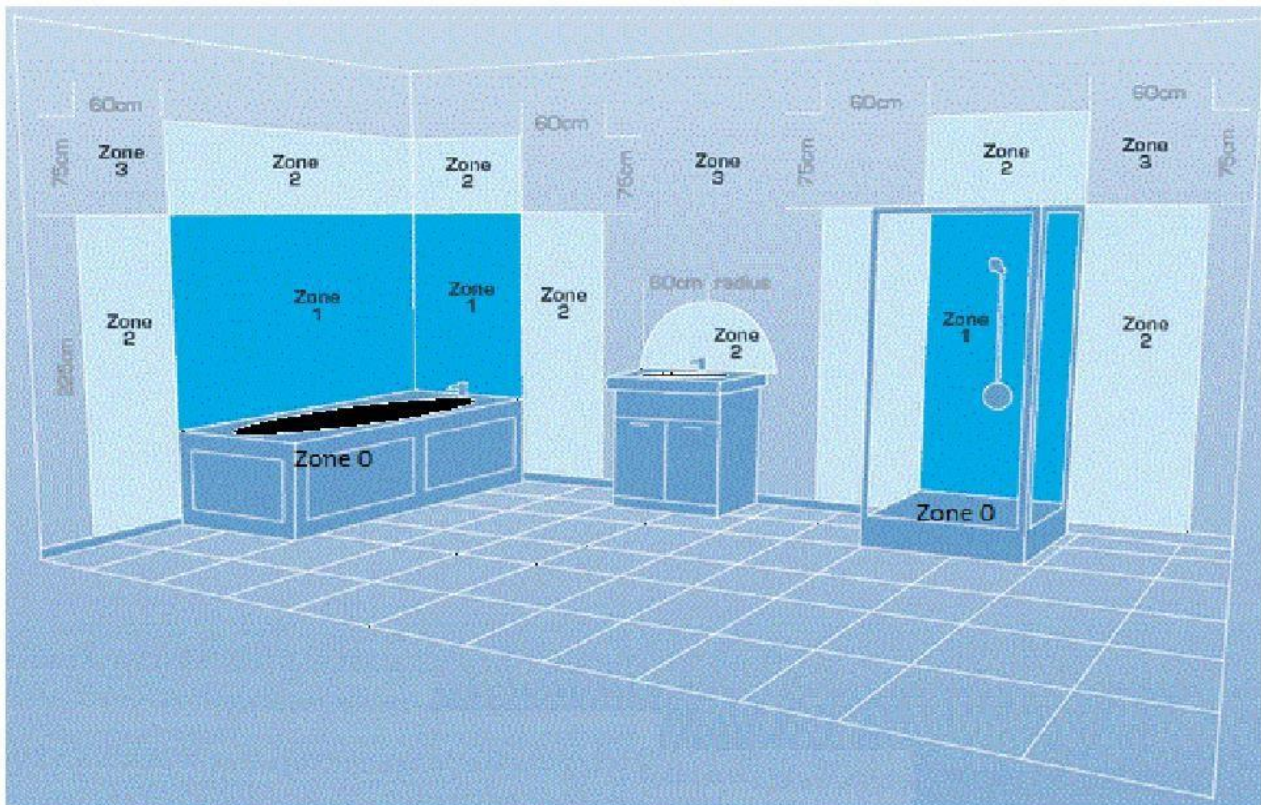

Zone 0:	The interior of the bathtub or shower basin.
Zone 1:	The area around the bathtub or shower basin up to a height of 2.25m above the floor
Zone 2:	The area stretching to 0.6m outside the bath or shower and above the bath or shower if over 2.25m

PARTS

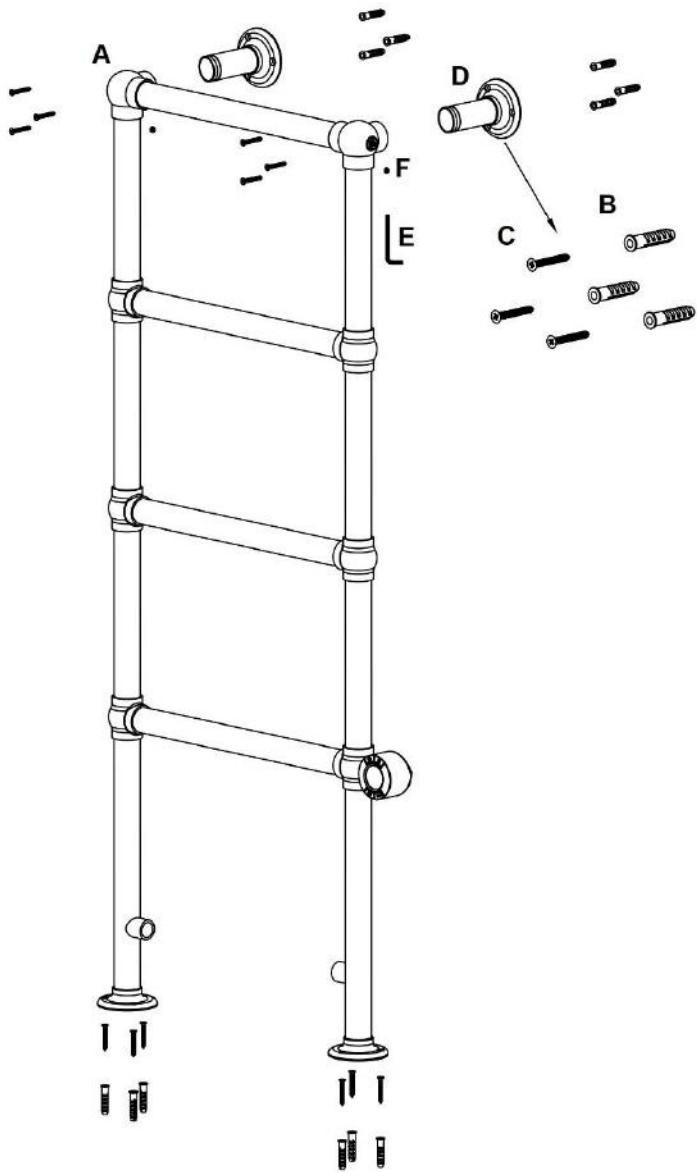

No.	Description	Qty.
A	Towel Warmer	1
B	Wall Plug	12
C	Screw	12
D	Wall Bracket	2
E	Allen Key	1
F	Grub Screw	2

Tools Required:

- Spanner
- Flat head Screwdriver
- Phillips Screwdriver
- Tape Measure
- Drill and 8mm Drill Bit
- Spirit Level
- Pencil
- Gloves

INSTALLATION

IMPORTANT: Before drilling, ensure the wall you are mounting the appliance on is free of pipes and wires.

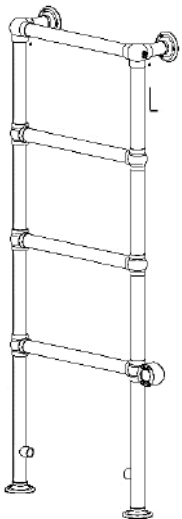

1. Secure each wall bracket to the Towel Warmer using the two Grub Screws provided.

2. Using your appliance as a guide, mark the drill points on the wall and floor in line with the screw holes on the feet and top of the towel warmer.

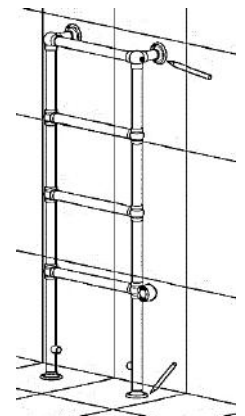

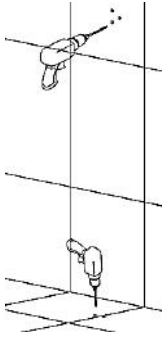

3. Drill the holes using an 8mm drill bit. If you are drilling into tile, use tape at the drill points to avoid slippages.

4. Insert the wall plugs into the holes.

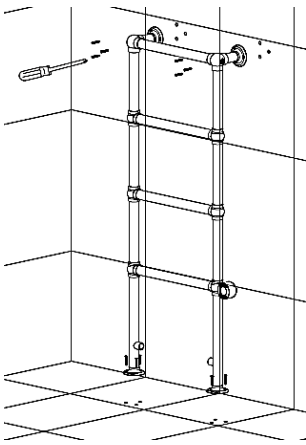
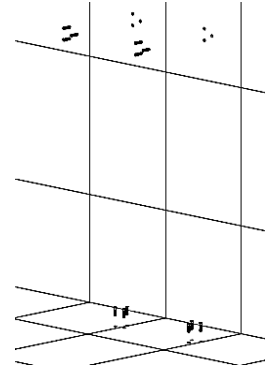

5. Secure the appliance to the wall using the screws.

6. Finally, connect the appliance to your electrics. You will need a competent person to hard wire the appliance into your home, following all local guidelines. The appliance's rated power is 300w and can be connected to a 3A MCB.







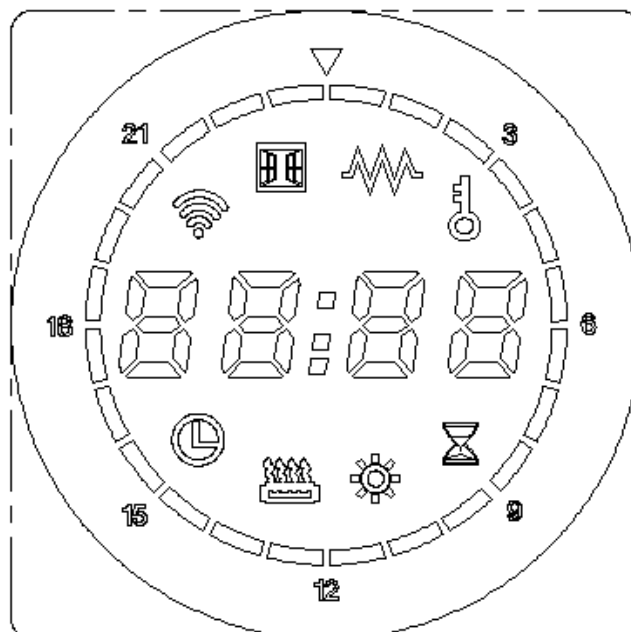

IMPORTANT: The towel warmer is pre-filled with water and glycol solution; please take care not to spill this.

OPERATION

Your appliance can work in ambient temperatures of 0-55°C.



IMPORTANT: If you download the Tuya app as described later, you can set up and change your settings using your phone rather than the control panel.

	<p>Power: Press once to turn it on and once to turn it off. The standby screen will show the time.</p>
	<p>Menu: Repeatedly press the menu button to cycle through the functions in this order- Temperature setting mode, timer, default mode and scheduler.</p>
	<p>The increase and decrease buttons can be used to change the temperature and the time.</p> <p>NOTE: When using these buttons to set the time or temperature, holding the button down will speed up your selection.</p>
	<p>Free Mode: Press the menu to enter the temperature setting mode. Press the increase or decrease button to change the temperature by 1°C. Once in this mode, press the menu, and you will enter the timer mode.</p>
	<p>Timer: The temperature is set to 65°C and cannot be changed. You can set the time from 30 minutes to 8 hours. Press the increase button once to increase the time in 30-minute increments. Press the decrease button to decrease in the same way. Once in the timer mode, press the menu, and you will enter the default mode.</p>
	<p>Constant Mode: The temperature is set to 50°C and cannot be changed. Once in this mode, press the menu button, and you will enter the scheduler.</p>
	<p>Scheduler: You can set daily, weekly and long-term schedules. When you first enter this mode, you will need to set the current day and time. Each selection you enter will flash on the screen.</p> <p>Time Setting: Hold the menu button for 3 seconds and set the hour first using the increase and decrease buttons (0-23hrs). Once the hour is set, press menu once to set the minutes (00-59). Press the menu once, and you will enter the days of the week.</p> <p>Day Setting: Use the increase and decrease buttons to set the day of the week; Monday is 1, and Sunday is 7. Once you've set the day, press the menu once, and you will enter the weekly setting schedule. The bars surrounding the display will flash with selections.</p> <p>Weekly: Hold the menu button for 3 seconds, and you will be able to view/set the weekly settings. The bars surrounding the display will indicate the heating times by lighting up. See the example on the left. The schedule is set to heat from 5 am to 11:59 pm. You will enter Monday first, and the bars will flash to show which hour you are selecting. Press the increase button to select this as a heating hour and decrease for this hour to have no heating. Press the menu button to move to Tuesday and repeat this until you have set up all days. Once complete, press</p>
	

the **menu** button to enter the running state. To change this schedule, hold the **menu** button for 3 seconds, then follow the same instructions for setting.

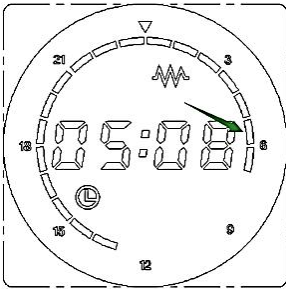

Running State: The display will show that day's current schedule. The heating times will flash on for 3 seconds and off for 1 second. The non-heating times will flash for 1 second and be off for 3. Please see the example on the left, showing it is 05:08, and the heating started at 5 a.m.

Child Lock: With the unit on, hold the increase and decrease buttons for 3 seconds to lock the controls. Only the power button will work when the control panel is locked. Hold the buttons for 3 seconds again to unlock.

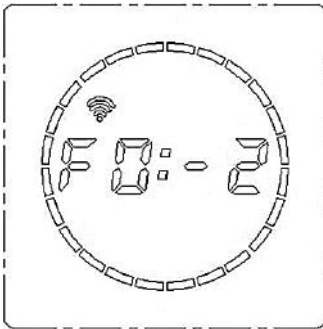

Internal Temperature Setting: With the unit on standby, hold the increase button for 10 seconds, and you will enter the temperature compensation settings. The default compensation is -2°C; press the increase or decrease button to change this in 1-degree increments. You can set this between -5 and 5°C. Press the menu button again to enter the Wi-Fi function.



Wi-Fi: Use the increase and decrease buttons to turn the Wi-Fi function on and off. To enter connectivity mode, hold the menu button for 3 seconds with the Wi-Fi function on. This will allow you to connect for 100 seconds. When connecting, the display will show PASS or FAIL. Pass means you are connected, and fail means it failed to connect.



Factory Reset: Hold the power button for 10 seconds, and the towel warmer will reset to the factory settings. After 5 seconds, press the power button again to turn the unit back on and set your desired selections. Wi-Fi will be on by default.

DISPLAY

The icons will appear on the display to show you your current selection. When the unit has a schedule set up, this will be shown using black flashing blocks. These will flash on for 3 seconds, then off or 1.

SETTING UP THE WIFI APP

This is designed as a general guide to the setup. There may be differences in the interface and features available due to product development and features of the model.

BEFORE YOU START

- Ensure your router provides a standard 2.4 GHz connection.
- If your router is dual-band, ensure that both networks have different network names (SSID). Your router's provider or Internet service provider can provide advice specific to your router.
- Place the device as close as possible to the router during setup.
- Once the app has been installed on your phone, turn off the data connection and ensure your phone is connected to your router via Wi-Fi.

DOWNLOAD THE APP TO YOUR PHONE

You can download the "TUYA SMART" app from your chosen app store by using the QR codes below or searching for the app in your chosen store.

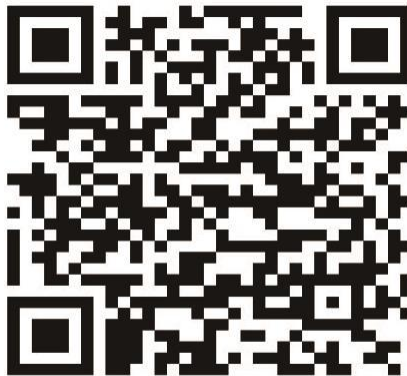

Android



IOS

APP CONNECTION

NOTE: Due to continuous product improvement, some images may differ from the current app. You can download it from the Apple or Google Play Store.

1. Press the register button at the bottom of the screen.
2. Read the Privacy policy and press the Agree Button.
3. Enter your email address or phone number and press continue to register.

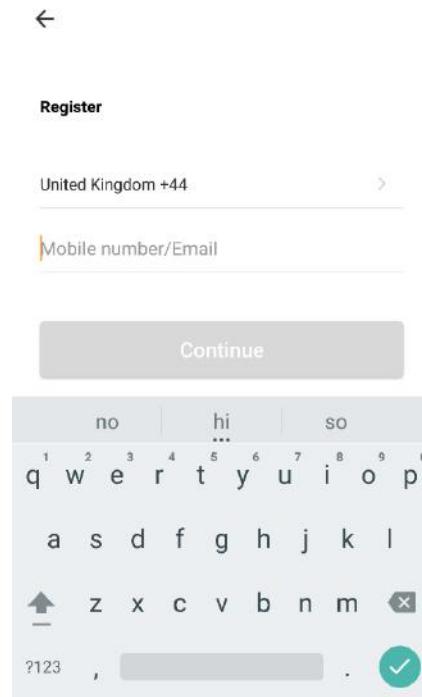
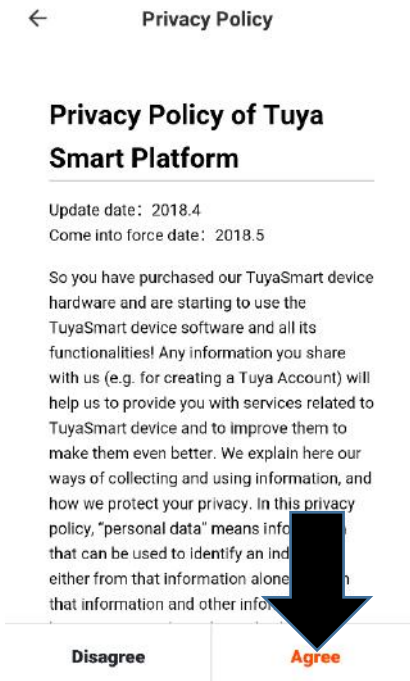
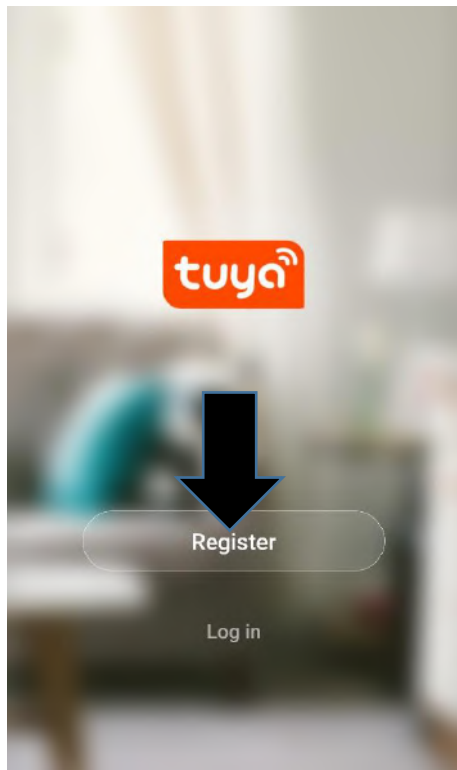

4. A verification code will be sent using the method selected in step 3. Enter the code into the app.
5. Type in the password you would like to create. This needs to be 6-20 characters, with letters and numbers.
6. The app is now registered. It will automatically log you in following registration.

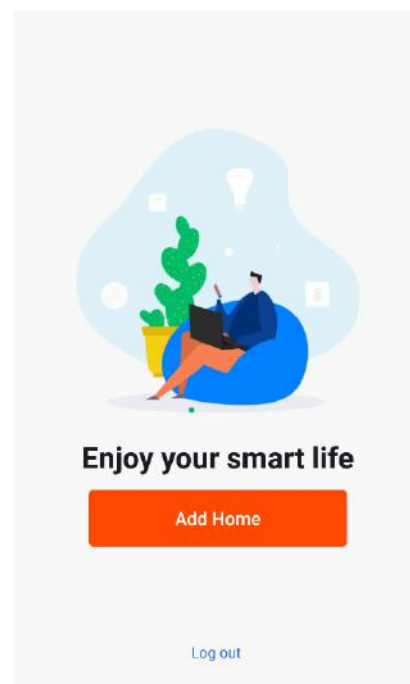
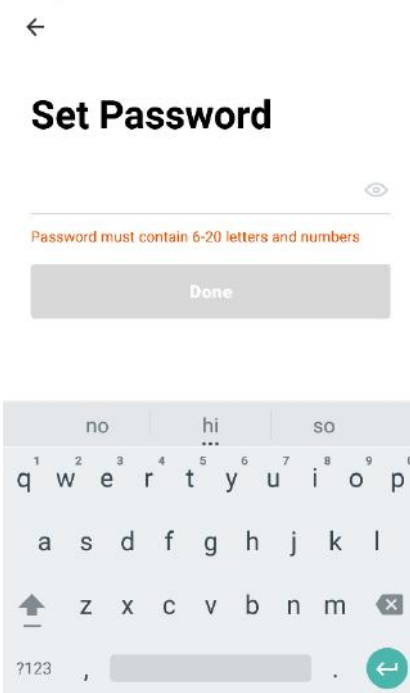
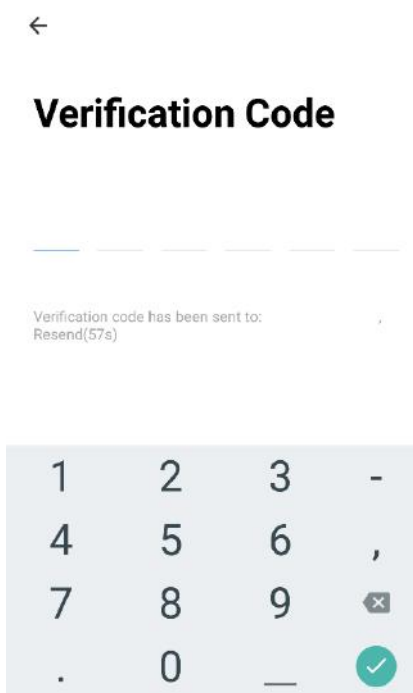

SETTING UP YOUR HOME WITHIN THE APP

The app allows you to have multiple homes, rooms, and devices, so you will need to set up at least one to get started.

1. Select 'Me' at the bottom of the screen, then 'Home Management'.

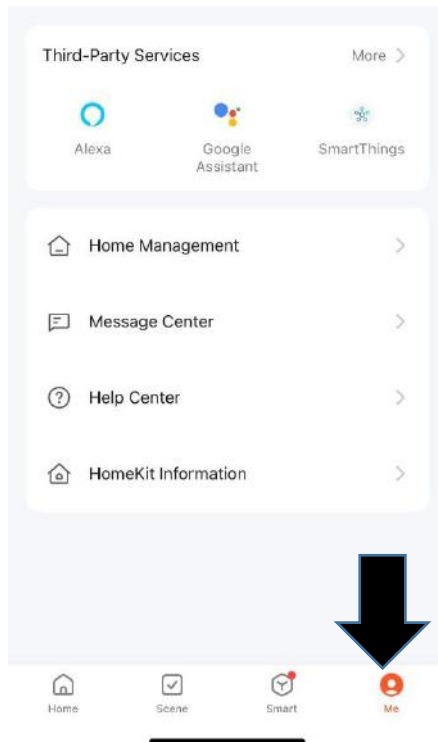

2. Create and name your home, join a home or use the home you have set up already.



3. Select a location to either allow the app to pinpoint your location via GPS in your phone settings or type/ drop the pin on the map.



4. Select your rooms. Untick any rooms that you do not need. Click and add a room if you require more.

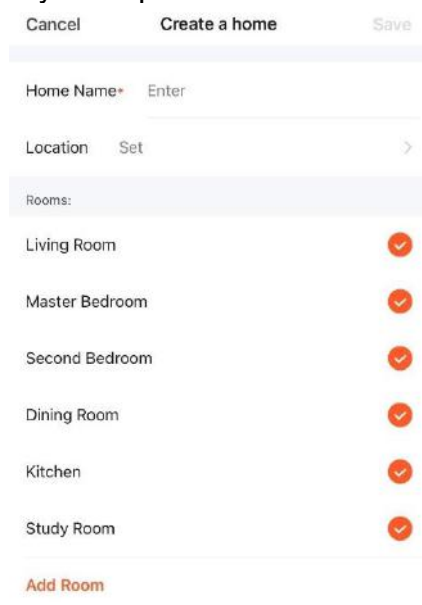

5. Add another room and type in the name or select an option. Then select confirm.

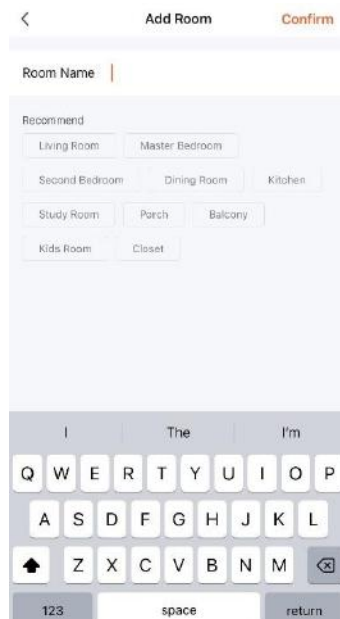

6. Select the room your unit is in. Then click on the green cross to add the device to that room, then save.

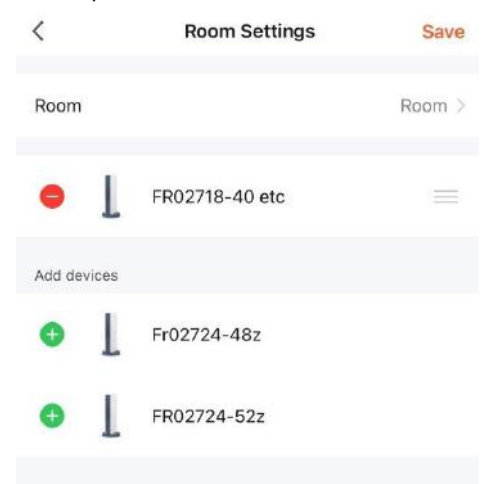

CONNECTING TO THE UNIT

1. Turn the towel warmer on using the power button, then ensure the unit is on standby.



2. Ensure the Wi-Fi function is on, then hold the menu button for 3 seconds to allow connectivity.



3. On the app, now select the 'Add' button in the top corner. Then 'Add Device'.

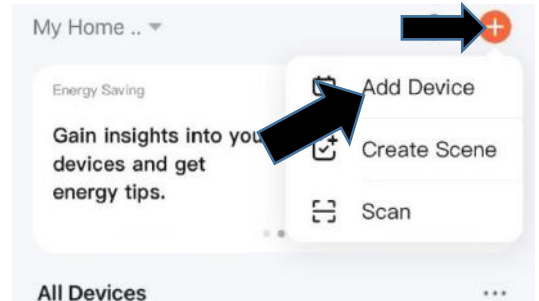

4. Ensure your phone is connected to the same Wi-Fi as the unit. Then select 'Small Home Appliances' and then electric towel warmers.



5. Confirm the indicator is blinking on the app (if it is, return to step 1 if not).

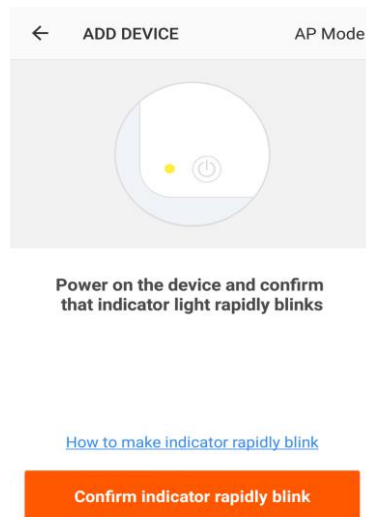

6. Enter the Wi-Fi password and then wait for the transfer of the settings to be completed.

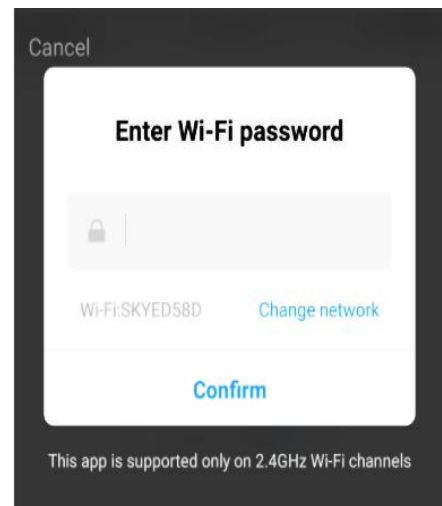

NOTE: You can also use your phone's wireless connection to boost the signal for connection.

HOME SCREEN

Voice Control: Press to give verbal instructions for operation.

Add Device: Add a device to the app and go through the setup process.

Name of Warmer: Press to enter the Device Screen

Home: Return to home screen from the Smart Scene and Profile screens

Profile: Provides the option for changing settings.

Scene: Allows you to program intelligent behaviour based on the internal and external environment.

Smart: Shows you smart insights and allows you to set up alerts, cameras and alarms.

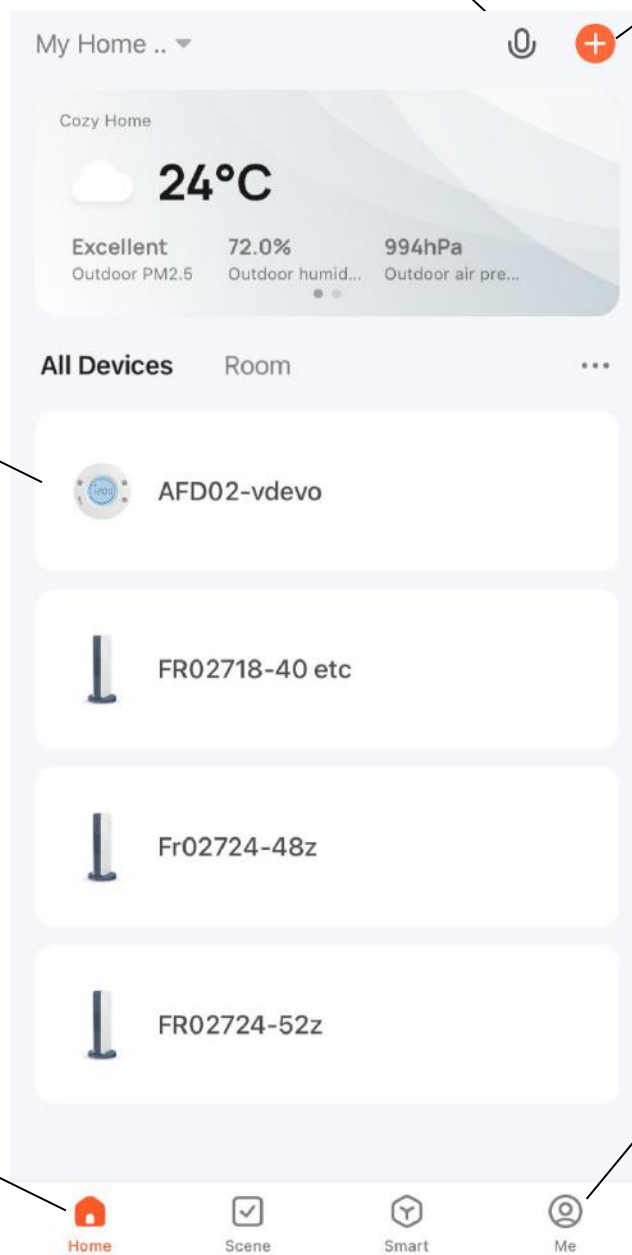

DEVICE SCREEN

Back: Returns to the Home Screen

Device Name

Edit Device

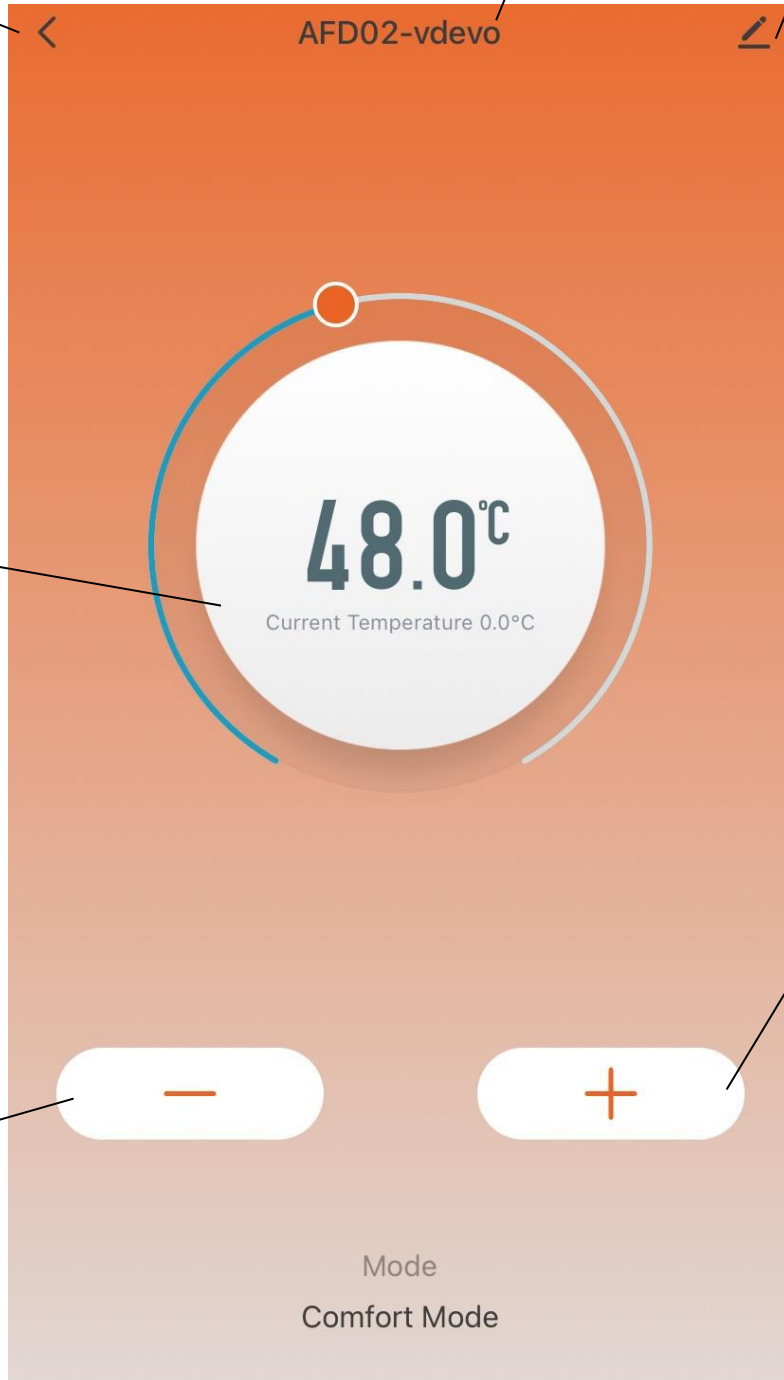

Desired Temperature: Displays what has been set as the target room temperature.

Increase Desired Temperature
Temperature range 30-70°C

Decrease Desired Temperature
Temperature range 30-70°C

Power: Use to turn the unit on or off



Switch

Mode: Select your desired mode.



Mode



Auto data



Setting

Settings: Enter the settings menu

Schedule: Enter and set your weekly schedule.

MODE

These modes match the ones on the control panel.

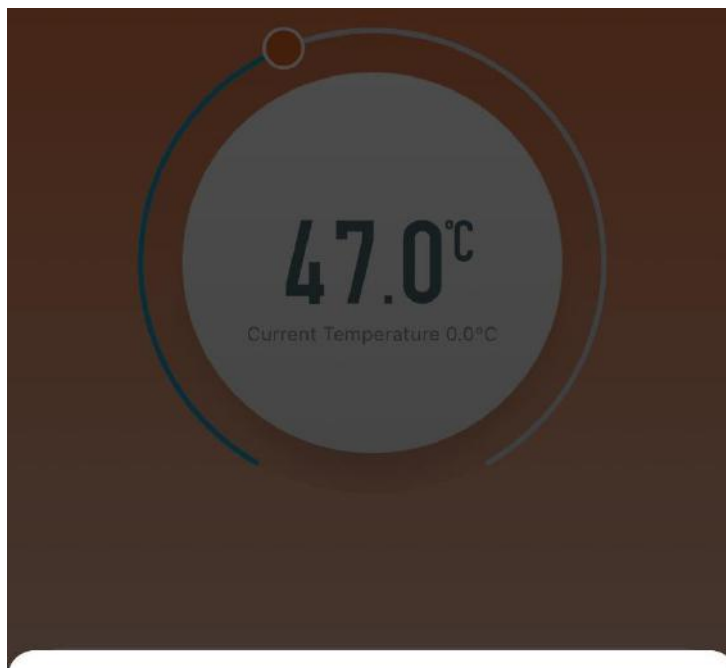

Mode

Free Mode

Timing Mode

Constant Mode

Schedule Mode

Cancel

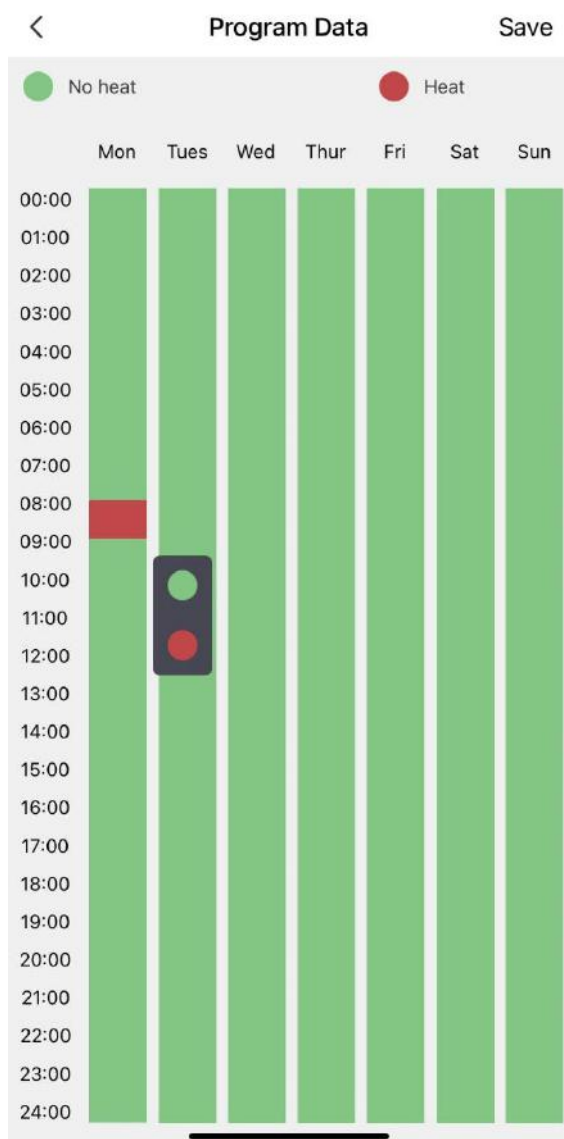

AUTO DATA

Use this to set the weekly schedule. Red indicates heating, and green is not heating. Press your desired hour, then select either green or red to select your schedule once you have selected your schedule, press save.

SETTINGS

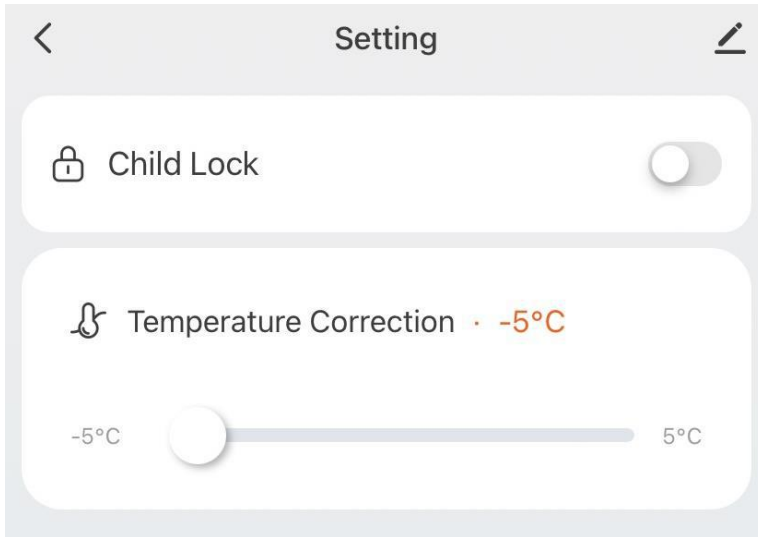

You can activate the child lock using the app.

You can also set the temperature correction here too.

EDIT DEVICE

Third-party control allows you to set up your towel warmer to be controlled via Alexa or Google Play.

Device information will allow you to view your device's specific details.

Tap to run, and automation is where you can also activate any smart scenes you have set up.

Create Group allows you to group appliances in your home so you can control these together.

You can share the device with members of your household and also add any other Tuya accounts you may have.

Message and notification settings allow you to choose between online or SMS notifications.

You can also opt to turn on offline notifications.

The help centre will help you with FAQs on the app.

You can also remove the device here if you no longer wish to use it or if you have switched devices.

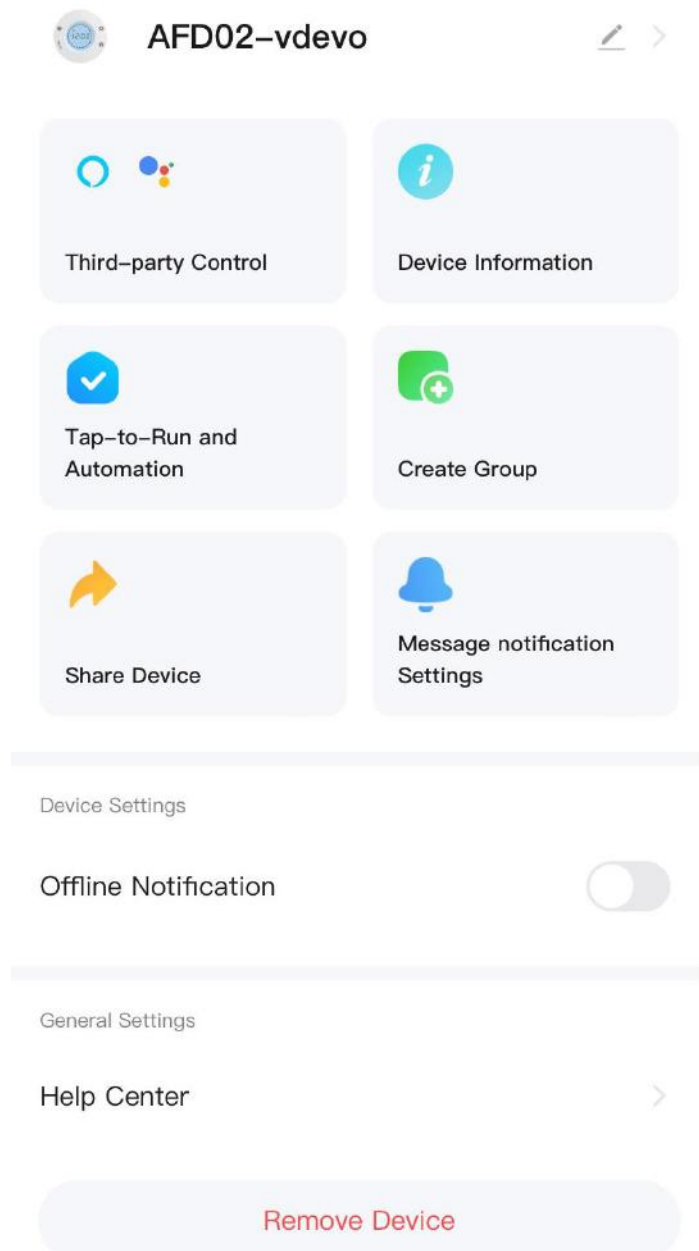

CLEANING AND MAINTENANCE

IMPORTANT: Always switch the towel warmer off and allow it to cool before cleaning.

The towel warmer is steel with a plated finish. To avoid damage or discolouration, wipe down your towel warmer regularly with a slightly damp cloth and then wipe dry. Ensure no water enters the gaps in the casing. Do not use bleach, strong abrasives, or materials that will scratch the surface. Do not pour water onto the appliance when cleaning it.

Always ensure the unit isn't run dry; you will rarely need to refill this, but if you do, ensure you purchase the correct water and glycol liquid solution. When filling, always use gloves and goggles and lay down a towel.

If you are removing the unit for storage, place it in the original box and store it in a cool, dry place.

TROUBLESHOOTING

Fault	Cause	Remedial measure
The device does not heat.	Is the device switched off?	Switch on the device or set the desired heat level.
	Is the regular temperature set too low?	Set the temperature regulator higher.
	No mains voltage?	Check cables
The temperature indicates "Er"	Temperature sensor open circuit or short circuit	Disconnect the device immediately from the power and contact a specialist or the provider.

TECHNICAL SPECIFICATION

Model	REGBBE1200 REGMBE1200
Voltage	230V 50Hz
Power	300W
IP Rating	IPX4
Dimensions(lxwxh)	130*479*1197 mm
Weight	11.8 kg

SUPPORT

If you should encounter an issue with the operation/function of your product, don't hesitate to get in touch with BID Customer Service.

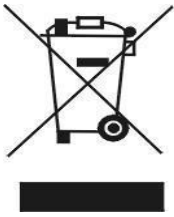

Recycling facilities are now available for all customers, where they can deposit their old electrical products. Customers can take any old electrical equipment to participating sites run by their local councils. Please remember that this equipment will be further handled during the recycling process, so please be considerate when depositing your equipment. Please contact the local council for details of your local household waste recycling centres.

At the time of printing, the product contained no substances listed within Annex XIV of the Reach Regulations (EC) 1907/2006. In accordance with Article 59 of the same regulation, the following substances are contained within the product at permitted levels: Lead and cadmium.

As a responsible manufacturer, we monitor the regulations to ensure continued compliance. Further information can be provided upon request.

PSTI STATEMENT OF COMPLIANCE

Description: Towel Warmer

Model Number: REGBBE1200 and REGMBE1200

Manufacturer: electriQ, 2A Trident Business Park, Leeds Road, Huddersfield, HD2 1UA

PSTI Contact: TiSecurity@buyitdirect.co.uk

We have prepared this statement of compliance and can confirm that this product is compliant with the deemed compliance conditions in Schedule 2 of The Product Security and Telecommunications Infrastructure (Security Requirements for Relevant Connectable Products) Regulations 2023.

Duration of security updates: 06/07/2026. This date is correct at the time of printing, but we may extend it. Please visit www.electriQ.co.uk for the latest information and details of our PSTI compliance.



Richard Leach

Compliance and Quality Manager, Buy It Direct, Huddersfield

21st August 2024

EU DECLARATION OF CONFORMITY

Hereby, Better Bathrooms declares that these towel rails are in compliance with Directive 2104/53/EU.

The full text of the EU Declaration of Conformity is available at the following internet addresses:

www.betterbathrooms.com/files/DOC/EU/REGBBE1200.pdf

www.betterbathrooms.com/files/DOC/EU/REGMBE1200.pdf

UK DECLARATION OF CONFORMITY

Hereby, Better Bathrooms declares that these towel rails are in compliance with the Radio Equipment Regulations 2017

The full text of the EU Declaration of Conformity is available at the following internet addresses:

www.betterbathrooms.com/files/DOC/UK/REGMBE1200.pdf

www.betterbathrooms.com/files/DOC/UK/REGBBE1200.pdf

For more information

- visit betterbathrooms.com
- email customerservices@buyitdirect.co.uk
- call 0871 244 0935
- write to Trident Business Park, Neptune Way, Huddersfield, HD2 1UA

**better
bathrooms**

Part of the BuyItDirect Group